

SIRIUS HRI

High-pressure discharge lamps with reflector



Druh použití

- Architecture & Architainment

Výhody produktu

- Lightweight and compact reflector lamps
- Perfectly suited for small and lightweight moving heads
- Optimalizovaný design hořáku umožňuje jakoukoli polohu hoření
- High luminance through very short arc and high pressure
- Jasně světlo pro oslnivé světelné efekty
- Dlouhá životnost
- Easy lamp replacement
- Stable light output over the entire lifetime



Technický list řady výrobků

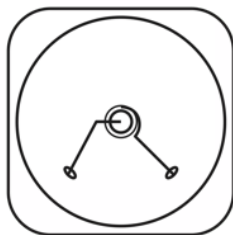
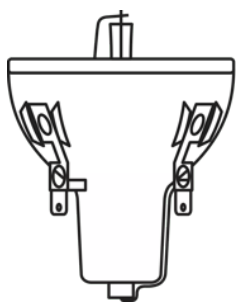

666507_SIRIUS HRI 100W

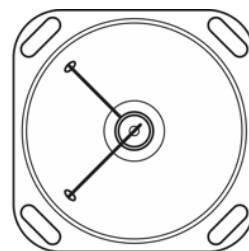
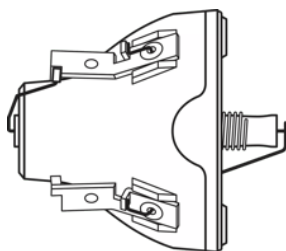

350611_SIRIUS HRI 132W

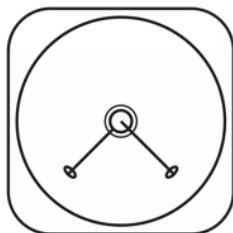
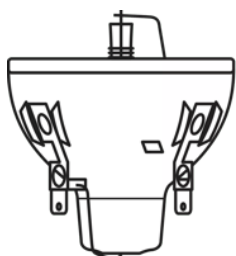

488735_SIRIUS HRI 132W

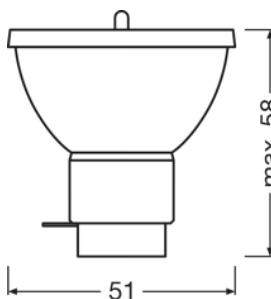

SIRIUS HRI 251W

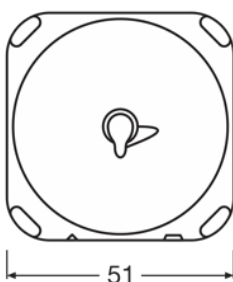
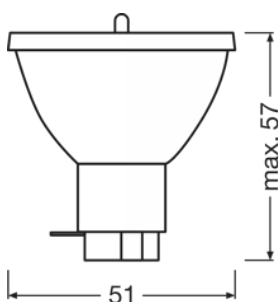

SIRIUS HRI 295 W

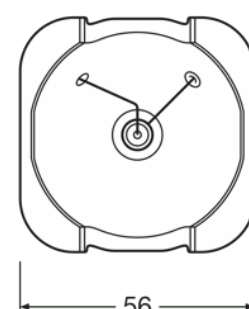
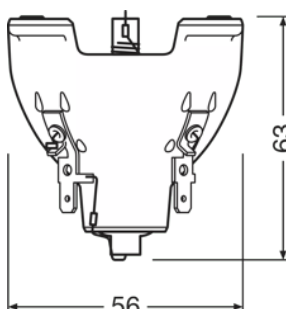

501950_SIRIUS HRI 330W

Technický list řady výrobků

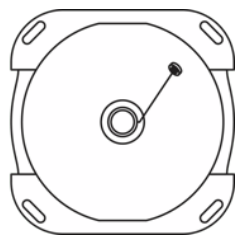
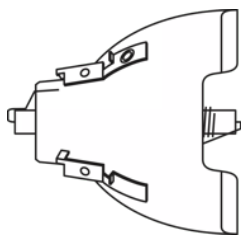

333382_SIRIUS HRI 330W

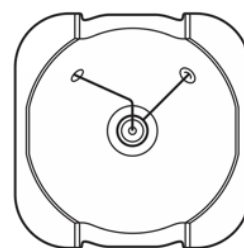
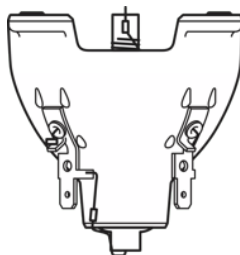

501965_SIRIUS HRI 330W

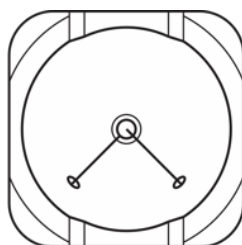
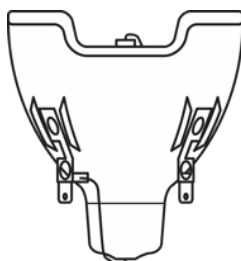

488771_SIRIUS HRI 330W X8

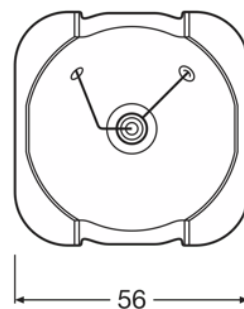
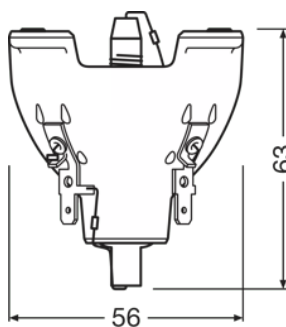

501949_Sirius HRI 330W XL

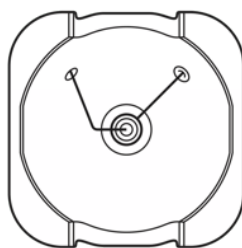
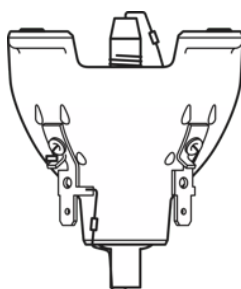

501963_Sirius HRI 330W XL

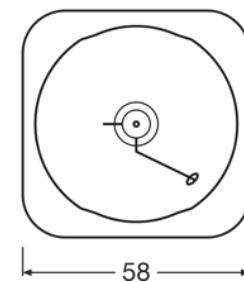
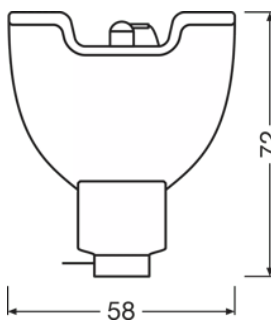

SIRIUS HRI 371W

Technický list řady výrobků

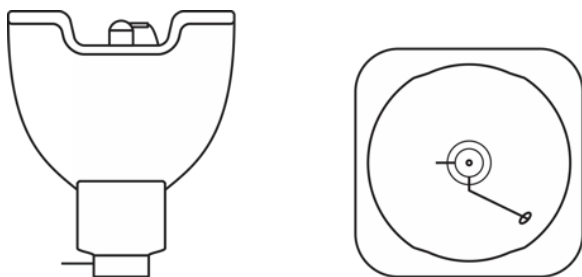

SIRIUS HRI 371W

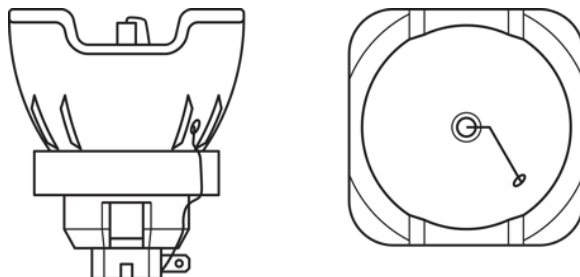

668858_SIRIUS HRI 440W

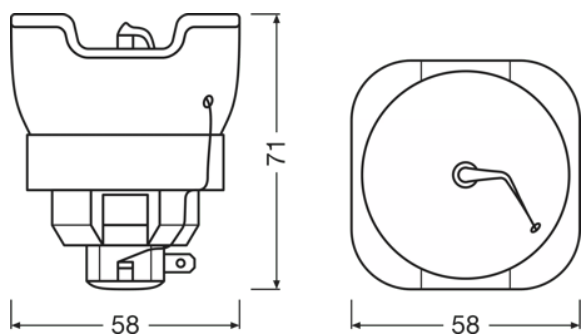

SIRIUS HRI 580 F

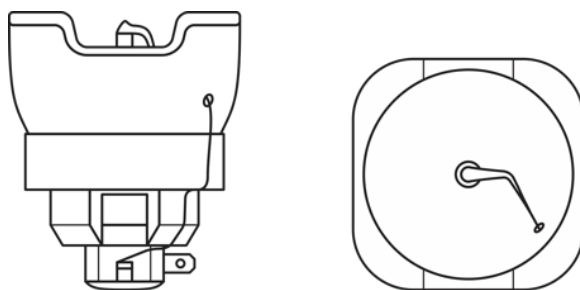

SIRIUS HRI 580 F

Technický list řady výrobků

Technické údaje

Popis výrobku	Parametry		Fotometrické údaje				Světelně-technické údaje
	Jmenovitý výkon	Jmenovitý proud	Jmenovitý světelný tok	Teplota chromatičnosti	Index podání barev Ra	Maximální teplota chromatičnosti	Ohnisko a vzdálenost
SIRIUS HRI 100 W	100.00 W	1.8 A	3680 lm	9000 K	60	9300 K	30.0 mm
SIRIUS HRI 132 W SC	132.00 W	1.8 A	5150 lm	9200 K	60	9200 K	37.7 mm
SIRIUS HRI 140 W RO	140.00 W	1.9 A	5400 lm	9200 K	60	9200 K	37.7 mm
SIRIUS HRI 190 W+	190.00 W	2.7 A	8100 lm	8200 K	73		
SIRIUS HRI 230 W	230.00 W	3.3 A	9500 lm	8000 K	75	8000 K	34,5 mm
SIRIUS HRI 231 W	231.00 W	3.3 A	10800 lm	8000 K	75		
SIRIUS HRI 251 W	250.00 W	3.5 A	12000 lm	8000 K	77		
SIRIUS HRI 260 W PRO	260.00 W	3.7 A	13500 lm	7800 K	79		
SIRIUS HRI 280 W	280.00 W	4 A	11500 lm	7800 K	78	7800 K	35.5 mm
SIRIUS HRI 280 W RO	280.00 W	4 A	11500 lm	7800 K	78		
SIRIUS HRI 281 W	281.00 W	4 A	13000 lm	7800 K	78		
SIRIUS HRI 295 W	295.00 W	4.1 A	11300 lm	7800 K	78		
SIRIUS HRI 310 W	310.00 W	4.5 A	15000 lm	8000 K	84		
SIRIUS HRI 310 W RO	310.00 W	4.8 A	13000 lm	8500 K	78		
SIRIUS HRI 310 W PRO	310.00 W	5 A	15500 lm	7650 K	85		
SIRIUS HRI 311 W	310.00 W	3.3 A	14500 lm	8000 K	75		
SIRIUS HRI 330 W	330.00 W	5 A	18000 lm	7400 K	86	7400 K	31.0 mm
SIRIUS HRI 330 W X8	330.00 W	4.4 A	18000 lm	8000 K	85		
SIRIUS HRI 330 W XL	330.00 W	5 A	16500 lm	7250 K	71		
SIRIUS HRI 371 W	371.00 W	5 A	18300 lm	7650 K	85		
SIRIUS HRI 371 W S	371.00 W	5 A	19800 lm	7650 K	85		
SIRIUS HRI 371 W +	370.00 W	5 A	18300 lm	7650 K	85		
HRI 371 W S +	370.00 W	5 A	19800 lm	7650 K	85		
SIRIUS HRI 381 W S	380.00 W	5 A	20000 lm	7700 K	85		
SIRIUS HRI 380 W Pro	380.00 W	5 A	20000 lm	7700 K	85		
SIRIUS HRI 380 W S PRO	380.00 W	5 A	20000 lm	7700 K	85		
SIRIUS HRI 382 W	382.00 W	5.4 A	21000 lm	7650 K	85		
SIRIUS HRI 382 W S	380.00 W	5.4 A	20000 lm	7650 K	85		
SIRIUS HRI 420 W	420.00 W	5 A	22000 lm	7700 K	85		
SIRIUS HRI 420 W S	420.00 W	5 A	21000 lm	7700 K	85		
SIRIUS HRI 440 W	440.00 W	5.3 A	20000 lm	7000 K	80	7000 K	41.0 mm
SIRIUS HRI 440 W +	440.00 W	5.3 A	22800 lm	7000 K	80		
SIRIUS HRI 440 W H	440.00 W	5.3 A	18000 lm	7000 K	75		
SIRIUS HRI 440 W S	440.00 W	4.4 A	22800 lm	7000 K	80		
SIRIUS HRI 440 W X	440.00 W	5.3 A	22800 lm	7000 K	80		
SIRIUS HRI 461 W	461.00 W	5.3 A	24000 lm	7500 K	80		
SIRIUS HRI 461 W S	461.00 W	5.3 A	24000 lm	7500 K	80		

Technický list řady výrobků

Popis výrobku	Parametry		Fotometrické údaje				Světelně-technické údaje
	Jmenovitý výkon	Jmenovitý proud	Jmenovitý světelný tok	Teplota chromatičnosti	Index podání barev Ra	Maximální teplota chromatičnosti	Ohnisko vá vzdálenost
SIRIUS HRI 462 W	295.00 W	6.20 A	24000 lm	7900 K	85		
SIRIUS HRI 470 W	470.00 W	5.3 A	20500 lm	7000 K	80		
SIRIUS HRI 470 W S	470.00 W	5.3 A	21500 lm	7000 K	80		
SIRIUS HRI 470 W RO	470.00 W	5.3 A	19500 lm	7500 K	80		
SIRIUS HRI 470 W XL	470.00 W	5.3 A	24000 lm	7500 K	80		
SIRIUS HRI 471 W SN	471.00 W	5.3 A	20000 lm	7500 K	80		
SIRIUS HRI 550 W	550.00 W	6.1 A	28000 lm	7000 K	75		
SIRIUS HRI 550 W XL	550.00 W	6.1 A	28000 lm	7500 K	75		
HRI 580 W F	580.00 W	6.1 A	29500 lm	7000 K	75		

Popis výrobku	Maximální velikost štěrbin	Rozměry & váha		Životnost	Vlastnosti	
		Průměr	Délka	Střední doba života	Provozní poloha hořáku	Chlazení
SIRIUS HRI 100 W	5x3.8 mm	45.0 mm	53.0 mm	6000 h	Jakýkoli	Nucený
SIRIUS HRI 132 W SC	5x3.8 mm	46.0 mm	max. 44 mm	6000 h	Jakýkoli	Nucený
SIRIUS HRI 140 W RO	5x3.8 mm	46.0 mm	max. 44 mm	6000 h	Jakýkoli	Nucený
SIRIUS HRI 190 W+		51.0 mm	54.5 mm	3000 h		
SIRIUS HRI 230 W	5x3.8 mm	51.0 mm	54.5 mm	2500 h	Jakýkoli	Nucený
SIRIUS HRI 231 W		51.0 mm	50.0 mm	2000 h	Jakýkoli	
SIRIUS HRI 251 W		51.0 mm	61.0 mm	3000 h		
SIRIUS HRI 260 W PRO		51.0 mm	50.0 mm	6000 h		
SIRIUS HRI 280 W	5x3.8 mm	51.0 mm	54.5 mm	2000 h	Jakýkoli	Nucený
SIRIUS HRI 280 W RO		51.0 mm	54.5 mm	2000 h	Jakýkoli	
SIRIUS HRI 281 W		51.0 mm	50.0 mm	2000 h	Jakýkoli	
SIRIUS HRI 295 W		51.0 mm	53.5 mm	2500 h		
SIRIUS HRI 310 W		51.0 mm	53.5 mm	2500 h		
SIRIUS HRI 310 W RO		60.0 mm	67.0 mm	4000 h	Jakýkoli	
SIRIUS HRI 310 W PRO		58.0 mm	72.0 mm	6000 h		
SIRIUS HRI 311 W		51.0 mm	50.0 mm	1500 h		
SIRIUS HRI 330 W	8.0 mm	56.0 mm	63.0 mm	1500 h	Jakýkoli	Nucený
SIRIUS HRI 330 W X8		58.0 mm	66.0 mm	1500 h	Jakýkoli	
SIRIUS HRI 330 W XL		56.0 mm	63.0 mm	1500 h	Jakýkoli	
SIRIUS HRI 371 W		58.0 mm	72.0 mm	1500 h	Jakýkoli	
SIRIUS HRI 371 W S		58.0 mm	72.0 mm	1500 h	Jakýkoli	
SIRIUS HRI 371 W +		58.0 mm	72.0 mm	3000 h		
HRI 371 W S +		58.0 mm	72.0 mm	3000 h		
SIRIUS HRI 381 W S		58.0 mm	72.0 mm	2500 h		
SIRIUS HRI 380 W Pro		58.0 mm	72.0 mm	2500 h		
SIRIUS HRI 380 W S PRO		58.0 mm	72.0 mm	6000 h		

Technický list řady výrobků

Popis výrobku	Maximální velikost štěrbin	Rozměry & váha		Životnost	Vlastnosti	
		Průměr	Délka	Střední doba života	Provozní poloha hořáku	Chlazení
SIRIUS HRI 382 W		58.0 mm	72.0 mm	2500 h		
SIRIUS HRI 382 W S		58.0 mm	72.0 mm	2500 h		
SIRIUS HRI 420 W		58.0 mm	72.0 mm	2500 h		
SIRIUS HRI 420 W S		58.0 mm	72.0 mm	2500 h		
SIRIUS HRI 440 W	8.0 mm	58.0 mm	71.0 mm	1500 h	Jakýkoli	Nucený
SIRIUS HRI 440 W +		58.0 mm	71.0 mm	1500 h		
SIRIUS HRI 440 W H		65.0 mm	60.0 mm	1500 h	Jakýkoli	
SIRIUS HRI 440 W S		11.8 mm	71.0 mm	1500 h	Jakýkoli	
SIRIUS HRI 440 W X		58.0 mm	71.0 mm	1500 h		
SIRIUS HRI 461 W		60.0 mm	67.0 mm	1500 h	Jakýkoli	
SIRIUS HRI 461 W S		60.0 mm	67.0 mm	1500 h	Jakýkoli	
SIRIUS HRI 462 W		58.0 mm	72.0 mm	2000 h		
SIRIUS HRI 470 W		58.0 mm	71.0 mm	1500 h	Jakýkoli	
SIRIUS HRI 470 W S		58.0 mm	71.0 mm	1500 h	Jakýkoli	
SIRIUS HRI 470 W RO		60.0 mm	67.0 mm	1500 h	Jakýkoli	
SIRIUS HRI 470 W XL		60.0 mm	67.0 mm	1500 h	Jakýkoli	
SIRIUS HRI 471 W SN		60.0 mm	67.0 mm	1500 h	Jakýkoli	
SIRIUS HRI 550 W		60.0 mm	67.0 mm	1500 h		
SIRIUS HRI 550 W XL		60.0 mm	67.0 mm	1500 h		
HRI 580 W F		65.0 mm	65.0 mm	1000 h		

Popis výrobku	Certifikáty & standardy	Environmental information Information according Art. 33 of EU Regulation (EC) 1907/2006 (REACH)		
	EEL – Energetický štítek	Date of Declaration	Primary Article Identifier	Candidate List Substance 1
SIRIUS HRI 100 W	B	06-03-2024	4052899321656 4052899329119	No declarable substances contained
SIRIUS HRI 132 W SC	A	06-03-2024	4052899011335 4052899028708 4052899197404	No declarable substances contained
SIRIUS HRI 140 W RO	A	06-03-2024	4052899224056 4052899258969	No declarable substances contained
SIRIUS HRI 190 W+		07-03-2024	4008321866592 4052899475397	No declarable substances contained
SIRIUS HRI 230 W	A	05-03-2024	4008321678225 4008321810311	No declarable substances contained
SIRIUS HRI 231 W	A	06-03-2024	4052899512634 4052899553521 4062172041430 4062172128681 4062172212311	No declarable substances contained
SIRIUS HRI 251 W		07-03-2024	4062172212458 4062172212434	No declarable substances contained
SIRIUS HRI 260 W PRO		07-03-2024	4062172118941 4062172118927	No declarable substances contained

Technický list řady výrobků

Popis výrobku	Certifikáty & standardy	Environmental information Information according Art. 33 of EU Regulation (EC) 1907/2006 (REACH)		
	EEI – Energetický štítek	Date of Declaration	Primary Article Identifier	Candidate List Substance 1
SIRIUS HRI 280 W	A	05-03-2024	4008321734303 4008321810342	No declarable substances contained
SIRIUS HRI 280 W RO	A	06-03-2024	4052899082151 4052899110397	No declarable substances contained
SIRIUS HRI 281 W	A	06-03-2024	4052899553552 4062172041454 4062172128704	No declarable substances contained
SIRIUS HRI 295 W		26-10-2023	4062172283328 4062172283304	No declarable substances contained
SIRIUS HRI 310 W		07-12-2023	4062172202169 4062172202183	
SIRIUS HRI 310 W RO		07-12-2023	4062172013536 4062172063449 4062172140867 4062172140843	No declarable substances contained
SIRIUS HRI 310 W PRO		07-03-2024	4062172085304 4062172169424 4062172169455	No declarable substances contained
SIRIUS HRI 311 W		07-03-2024	4062172169363	
SIRIUS HRI 330 W		05-03-2024	4008321754448 4008321810373	No declarable substances contained
SIRIUS HRI 330 W X8	A	06-03-2024	4052899140295 4052899140325 4052899224346	No declarable substances contained
SIRIUS HRI 330 W XL		06-03-2024	4008321848765 4052899195431	No declarable substances contained
SIRIUS HRI 371 W		06-03-2024	4062172057004 4062172056984 4052899558649 4052899558670	No declarable substances contained
SIRIUS HRI 371 W S		06-03-2024	4062172056953 4062172056939 4052899558618	No declarable substances contained
SIRIUS HRI 371 W +		07-03-2024	4062172110341 4062172110327	No declarable substances contained
HRI 371 W S +		15-03-2024	4062172110396 4062172110372 4062172390729	No declarable substances contained
SIRIUS HRI 381 W S		22-12-2023	4062172226240 4062172226226	No declarable substances contained
SIRIUS HRI 380 W Pro		07-03-2024	4062172168625 4062172168601	No declarable substances contained
SIRIUS HRI 380 W S PRO		22-12-2023	4062172168335 4062172168311	No declarable substances contained
SIRIUS HRI 382 W		07-12-2023	4062172047135 4062172326131	No declarable substances contained
SIRIUS HRI 382 W S		07-12-2023	4062172033541 4062172326100	No declarable substances contained

Technický list řady výrobků

Popis výrobku	Certifikáty & standardy	Environmental information Information according Art. 33 of EU Regulation (EC) 1907/2006 (REACH)		
	EEL – Energetický štítek	Date of Declaration	Primary Article Identifier	Candidate List Substance 1
SIRIUS HRI 420 W		07-03-2024	4062172192750 4062172192736	No declarable substances contained
SIRIUS HRI 420 W S		26-10-2023	4062172192705 4062172192682 4062172392938 4062172392891 4062172393225 4062172393201	No declarable substances contained
SIRIUS HRI 440 W	A	06-03-2024	4052899222212 4052899259096 4052899553644 4052899570566 4052899587892	No declarable substances contained
SIRIUS HRI 440 W +		22-12-2023	4062172047333 4062172348874	No declarable substances contained
SIRIUS HRI 440 W H		06-03-2024	4052899509528 4052899576735	No declarable substances contained
SIRIUS HRI 440 W S	A	06-03-2024	4052899276543 4052899329140	No declarable substances contained
SIRIUS HRI 440 W X		07-03-2024	4062172017442	No declarable substances contained
SIRIUS HRI 461 W		06-03-2024	4052899532274 4052899553613	No declarable substances contained
SIRIUS HRI 461 W S		06-03-2024	4052899532298 4052899553583	No declarable substances contained
SIRIUS HRI 462 W		26-10-2023	4062172302128 4062172302104	No declarable substances contained
SIRIUS HRI 470 W		22-12-2023	4052899580961 4062172169332	No declarable substances contained
SIRIUS HRI 470 W S		06-03-2024	4052899580985 4062172169301	No declarable substances contained
SIRIUS HRI 470 W RO	A	17-05-2024	4052899476998 4052899477018 4062172392556	No declarable substances contained
SIRIUS HRI 470 W XL		06-03-2024	4052899581166 4062172017473 4062172168281	No declarable substances contained
SIRIUS HRI 471 W SN		06-03-2024	4052899581005 4062172040358	No declarable substances contained
SIRIUS HRI 550 W		06-03-2024	4062172008761 4062172078122	No declarable substances contained
SIRIUS HRI 550 W XL		27-10-2023	4062172008785 4062172168236 4062172168212	No declarable substances contained
HRI 580 W F		22-12-2023	4062172085267	No declarable substances contained

Technický list řady výrobků

Popis výrobku	Declaration No. in SCIP database
SIRIUS HRI 100 W	No declarable substances contained
SIRIUS HRI 132 W SC	In work
SIRIUS HRI 140 W RO	In work
SIRIUS HRI 190 W+	In work
SIRIUS HRI 230 W	In work
SIRIUS HRI 231 W	In work
SIRIUS HRI 251 W	No declarable substances contained
SIRIUS HRI 260 W PRO	In work
SIRIUS HRI 280 W	In work
SIRIUS HRI 280 W RO	In work
SIRIUS HRI 281 W	In work
SIRIUS HRI 295 W	No declarable substances contained
SIRIUS HRI 310 W	In work
SIRIUS HRI 310 W RO	In work
SIRIUS HRI 310 W PRO	In work
SIRIUS HRI 311 W	In work
SIRIUS HRI 330 W	In work
SIRIUS HRI 330 W X8	In work
SIRIUS HRI 330 W XL	In work
SIRIUS HRI 371 W	In work
SIRIUS HRI 371 W S	In work
SIRIUS HRI 371 W +	In work
HRI 371 W S +	In work
SIRIUS HRI 381 W S	In work
SIRIUS HRI 380 W Pro	In work
SIRIUS HRI 380 W S PRO	No declarable substances contained
SIRIUS HRI 382 W	In work
SIRIUS HRI 382 W S	No declarable substances contained
SIRIUS HRI 420 W	In work
SIRIUS HRI 420 W S	In work
SIRIUS HRI 440 W	In work
SIRIUS HRI 440 W +	No declarable substances contained
SIRIUS HRI 440 W H	In work
SIRIUS HRI 440 W S	In work
SIRIUS HRI 440 W X	No declarable substances contained
SIRIUS HRI 461 W	No declarable substances contained
SIRIUS HRI 461 W S	No declarable substances contained

Technický list řady výrobků

Popis výrobku	Declaration No. in SCIP database
SIRIUS HRI 462 W	No declarable substances contained
SIRIUS HRI 470 W	No declarable substances contained
SIRIUS HRI 470 W S	In work
SIRIUS HRI 470 W RO	In work
SIRIUS HRI 470 W XL	In work
SIRIUS HRI 471 W SN	In work
SIRIUS HRI 550 W	In work
SIRIUS HRI 550 W XL	In work
HRI 580 W F	No declarable substances contained

Technický list řady výrobků

Bezpečnostní pokyny

Z důvodu vysoké svítivosti, UV záření a vysokého vnitřního tlaku během provozu je možné výbojky SIRIUS HRI používat jen v uzavřených svítidlech speciálně konstruovaných pro tento účel. Vhodné filtry musí zajistit, aby bylo UV záření redukováno na přípustnou úroveň. V případě prasknutí světelného zdroje se uvolňuje rtuť. Musí být přijata zvláštní bezpečnostní opatření. Informace o bezpečnosti a manipulaci jsou k dispozici na vyžádání nebo v letáku dodaném se světelným zdrojem nebo v návodu k obsluze.

Pokyny k použití

Podrobnější informace k použití a grafiku najdete v technickém listu.

Vyloučení odpovědnosti

Změny bez předchozího upozornění vyhrazeny. Chyby a opomenutí vyhrazeny. Vždy se ujistěte, že používáte nejnovější vydání.